



User Manual

**M100**

**Maritime Survivor Locating Device**  
(Incorporating AIS and 121.5MHz)

English



© 2016 Ocean Signal Ltd

The technical data, information and illustrations contained in this manual were believed to be correct at the time of print. Ocean Signal Ltd reserve the right to change specifications and other information contained in this manual as part of our continual improvement process.

No part of this manual may be reproduced, stored in a retrieval system or transmitted in any form, electronic or otherwise, without the prior and express written permission of Ocean Signal Ltd.

No liability can be accepted for any inaccuracies or omissions in this manual.

Ocean Signal® is a registered trademark of Ocean Signal Ltd.

## IN CASE OF EMERGENCY



### Use only in situations of grave or imminent danger



If the M100 is correctly fitted to the life jacket or other personal flotation device (PFD), then the M100 will automatically activate on immersion in water.

This guide shows how to manually activate the M100.

- Press the green interlock button (1) in and slide the activation slide completely off. This can be done either from left to right as shown or from right to left. This will release the antenna and activate the M100

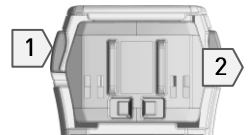

Keep eyes well away as the slide is removed as the antenna will spring out.

- If the indicator LED does not start flashing, manually switch the M100 on by pressing the ON Key (3)

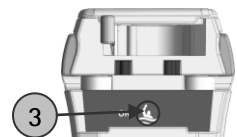

- Always turn off the M100 immediately after you have been rescued to avoid interference with other users. Refer to section 4.3 for deactivation instructions.

**CONTENTS**

IN CASE OF EMERGENCY..... 3

1. GENERAL..... 5

    1.1 Introduction..... 5

    1.2 M100X variant..... 5

    1.3 Exposure to RF Electromagnetic Energy..... 5

    1.4 Warnings..... 5

2. M100 OVERVIEW..... 6

3. LIFE JACKET INSTALLATION..... 8

    3.1 Fitting to a conventional bladder life jacket ..... 8

    3.2 Fitting to a sewn in bladder life jacket.....11

    3.3 Fitting to alternative type of life jackets .....15

4. Operation.....16

    4.1 Automatic Activation .....16

    4.2 Manual Activation.....16

    4.3 Deactivation.....16

    4.4 Rewinding the antenna.....17

5. Testing.....17

    5.1 Functional test.....17

    5.2 AIS transmission test.....18

6. Appendix.....19

    6.1 Maintenance and Troubleshooting .....19

    6.2 Batteries.....19

    6.3 Transport.....19

    6.4 Disposal.....19

    6.5 Specifications .....20

    6.6 Country of Intended Use.....20

    6.7 Approvals.....21

    6.8 Limited Warranty.....21

## 1. GENERAL

### 1.1 Introduction

The M100 Maritime Survivor Location Device (MSLD) provides the user with the latest technology specifically designed for professional use. The M100 is intended to alert your vessel in the event that you fall overboard. It will then plot your location on a suitable AIS equipped chart plotter and transmit a 121.5MHz locating signal that is compatible with all existing 121.5MHz direction finding equipment. The M100 is provided with options to allow fitting to lifejackets and immersion suits.

### 1.2 M100X variant

This user manual also applies to the installation and operation of the ATEX/IECEx M100X variant for use in hazardous areas.



Please read the M100X supplement to this user manual for important safety and operating warning relating to this product and its operation.

### 1.3 Exposure to RF Electromagnetic Energy

This product also complies with EN62479 (EU) and RSS-102 (Canada).

This product has been evaluated for compliance with the FCC RF exposure limits given in CFR 47 part 1.307(b) at a distance of greater than 5cms.

### 1.4 Warnings



This AIS transmitter is only intended for short range signalling to an AIS receiver installed on board your own vessel. It will not directly alert the emergency services or any other vessels.



This equipment is intended for emergency use only and it should not be used for routine tracking of persons or property, including routine tracking of divers.



If self-test is performed more frequently than once a month, then battery life may be reduced.



This radio device is designed to only provide an effective alerting and locating capability in close proximity to a vessel. This radio beacon is NOT an EPIRB.

## 2. M100 OVERVIEW

- 1) Interlock Button (both sides)
- 2) Antenna (behind activation slide)
- 3) Activation Slide (Grey)
- 4) Test Key Protection Slider (in closed position)
- 5) ON Key (for manual activation)
- 6) Indicator LED
- 7) TEST/OFF Key
- 8) Test Key Protection Slider (in open position)
- 9) Activation Tape
- 10) Tape Locking Clip (x4)
- 11) Buckle Patch and Tape
- 12) Oral Tube Mounting Bracket
- 13) Mounting Bracket
- 14) Mounting Bracket Attachment Tape
- 15) Alternative Activation Slide (Red)
- 16) Protective Cover (For use with item 15 only)
- 17) Interlock Button Locking Tool
- 18) Antenna Rewind Tool
- 19) Length of cord to tether the M100 (not shown)

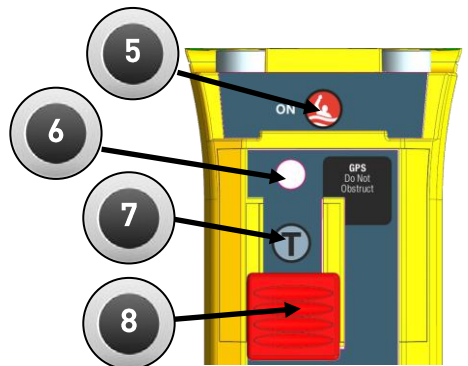
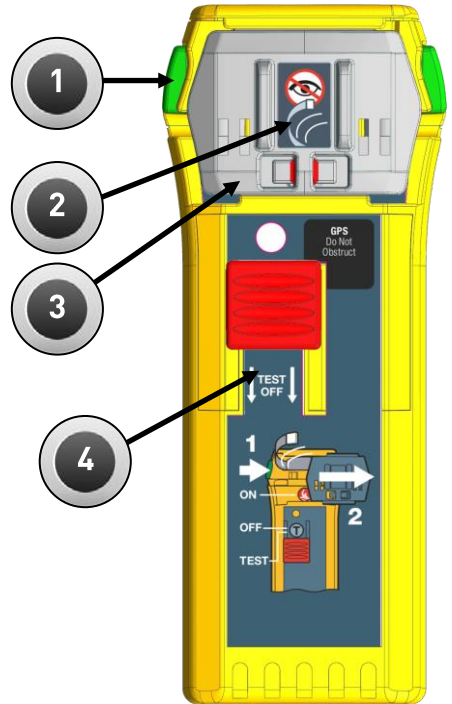

M100 Test Key protection slider shown in the open position

- ❗ The grey activation slider should only be used on a bladder where the activation tape can be passed all the way round the bladder.
- ❗ Only use the Tape locking kit with the grey Activation Slide.

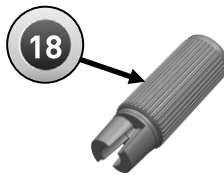
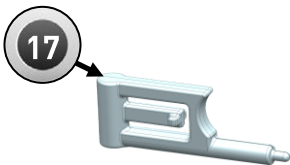
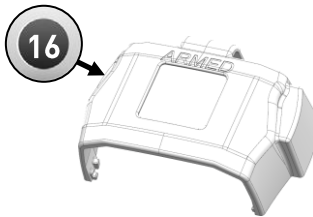
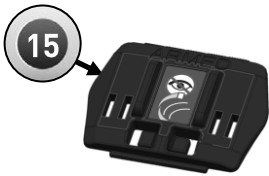
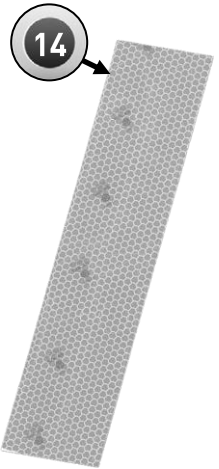
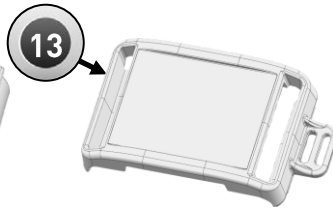
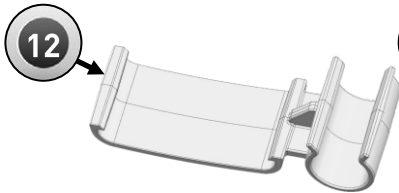
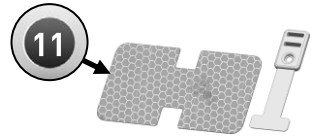
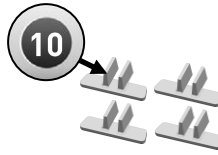
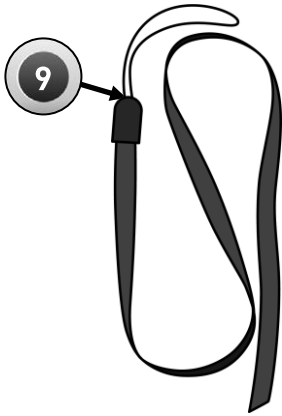

## 3. LIFE JACKET INSTALLATION

If your M100 is not already pre-installed into the lifejacket, please follow the instructions below carefully. When fitting the M100 to the oral tube, select the side with the widest part of the bladder underneath to support the M100. The following instructions are for fitting to the bladder on the left hand side of the jacket (as worn).

- 
 If the M100 has turned on during the installation process, make sure it is turned off by pressing and holding the TEST/OFF Key until the LED flashes red twice and release.

### 3.1 Fitting to a conventional bladder life jacket

This instruction relates to life jackets with bladders that are not attached to the cover where the M100 will be fitted.

- Prepare to fit the M100 to your life jacket by laying the jacket out flat. If the oral tube is not positioned in or near the centre of the bladder fit the M100 so it lays on the larger area of the bladder, usually the outside edge.
- 
 Avoid mounting the M100 at a position where the sides of the bladder are tapered. Failure to follow this warning may result in the tape sliding up the bladder so that it will try to release the slider at a steep angle.
- Noting which side the M100 will lay on when fitted, pass the loop of the Activation Tape through the green interlock button (1) and double the tape back through the loop (2).

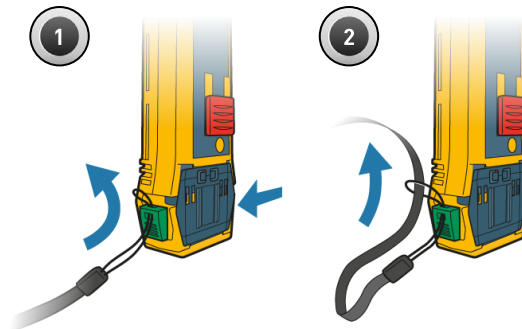

- Clip the M100 to the oral tube with the Oral Tube Mounting Bracket in the position as shown (3), with the top of the M100 facing towards the bottom of the life jacket, making sure the end of the oral tube is still available for manual inflation (4). The tape should lie over the oral tube when the M100 is mounted.



**!** The Oral Tube Mounting bracket should be placed as low as possible to the bottom of the oral tube, but so that the activation tape will not pass over angled edges of the bladder.

- Fit the Mounting Bracket Attachment Tape to the Mounting Bracket, then clip the Mounting Bracket to the rear of the M100 and press the tape down on to the bladder (5). Additional pressure should be applied to the tape from the rear of the bladder to ensure it is firmly adhered to the bladder material.

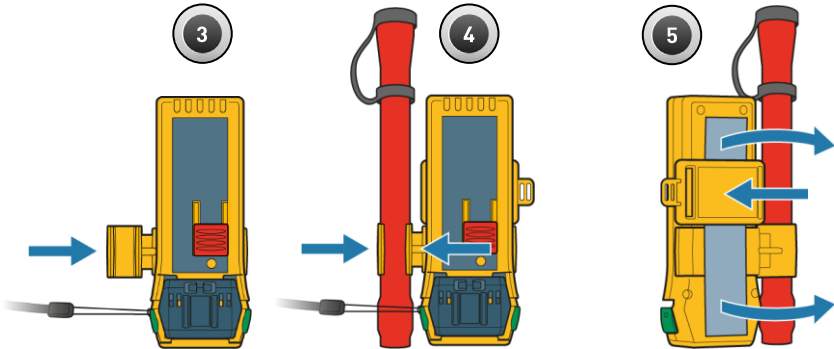

- Press the Green Interlock Button in and slide the Grey Activation Slide off the M100 (6).

**!** The antenna will spring out so take care to keep eyes away from this area.

- Rewind the antenna in the direction shown using the Rewind Tool. When it is completely wound, the tool can be pushed in to lock it in place (7).
- Press the Green Interlock Button in on the side nearest the oral tube and insert the Interlock Button Locking Tool in to the slot at the side to hold the button in place (8).

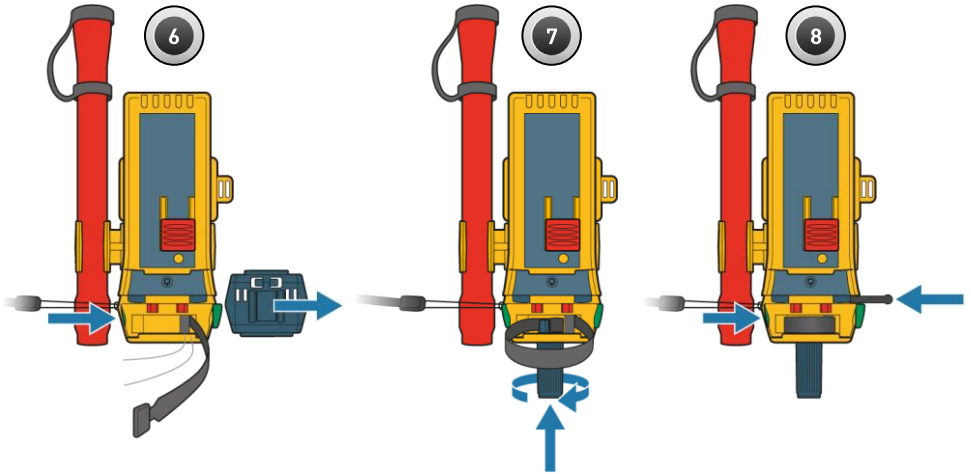

- Measure the width of the bladder at the position the tape will lie across (9).
- Using this measurement, hold or mark the tape at the distance from the edge of the M100 (10). This mark will be the position to fit the Tape Locking Clip in (12)

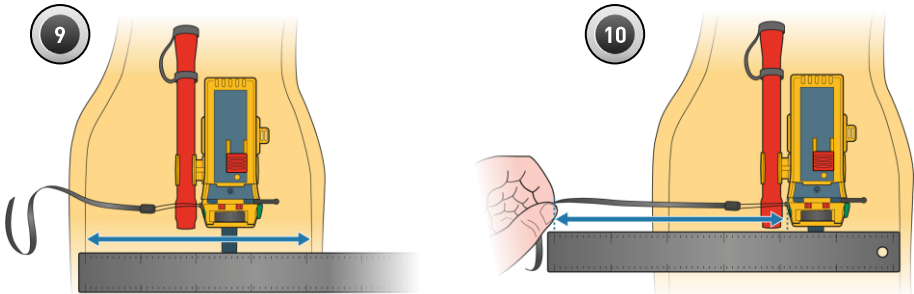

- Pass the tape under the bladder, without twisting it and attach the tape to the underside of the Grey Activation Slide using the Tape Locking Clip (11) and (12).

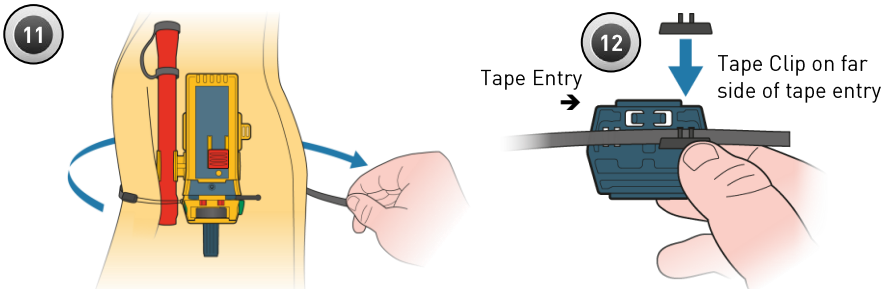

- ❗ Orientate the Tape Locking Clip as shown and lock the tape in position on the far side of the tape entry as indicated by the circle in (14).
- Holding the locking clip in place slide the Grey Activation Slide onto the body of the M100 and centre it (13).
- Release the Interlock Button Locking tool and check that the grey slider is locked in place. Remove the Antenna Winder (14).

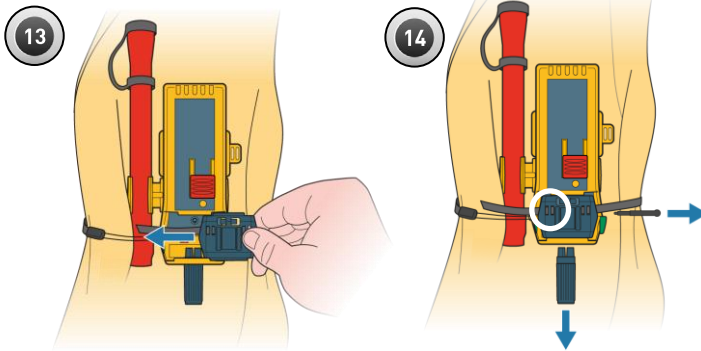

- ❗ Ensure you have removed the Antenna Winding Tool and the Interlock Button Locking Tool and retain for future use. Leaving these in place will stop the M100 activating correctly and may restrict the bladder inflating.
- To prevent accidental loss, use the provided length of cord to also tie the M100 to a fixed point on the lifejacket. Select a secure point on the lifejacket that the cord cannot detach or untie from if the M100 is accidentally removed from its bracket. The M100 fixing point for the cord is located on the top of the unit.
- ❗ **Ensure the M100 is securely tied to a fixed point on the lifejacket that will NOT inhibit inflation.**
- Repack the bladder into the cover in accordance with the manufacturer's recommendation, ensuring the bladder does not get trapped in the fastening mechanism or tangled up.

## 3.2 Fitting to a sewn in bladder life jacket

This instruction relates to life jackets with bladders that are attached to the cover, where the M100 will be fitted, but does not apply to jackets where the bladder is completely integrated with the cover (welded in bladder). Prepare to fit the M100 to your life jacket by laying the jacket out flat. Fit the M100 so it lies on the inside edge of the bladder, relative to the oral tube.

- Clip the Oral Tube clip to the rear of the M100 and attach to the oral tube (1) and (2).
- Fit the Mounting Bracket Attachment Tape to the Mounting Bracket and then clip the Mounting Bracket to the rear of the M100. Rotate the M100 round the oral tube until it is lying flat on the bladder and press the tape down on to the bladder (3). Additional pressure should be applied to the tape from the rear of the bladder to ensure it is firmly adhered to the bladder material.

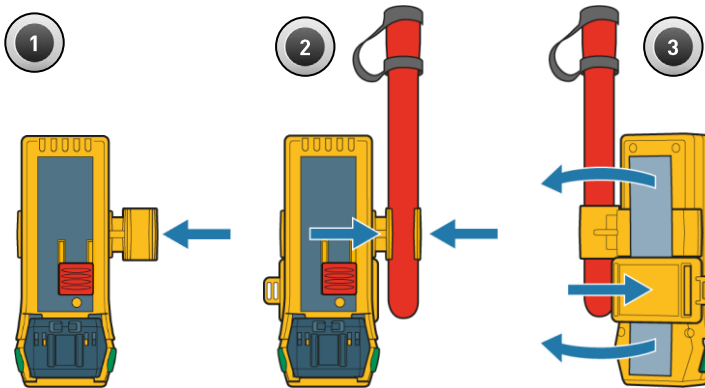

- Press the Green Interlock Button in and slide the Grey Activation Slide off the M100 (4). The antenna will spring out so take care to keep eyes away from this area. The grey slider will not be used in this fitting.
- Rewind the antenna in the direction shown using the Rewind Tool. When it is completely wound, the tool can be pushed in to lock it in place (5).

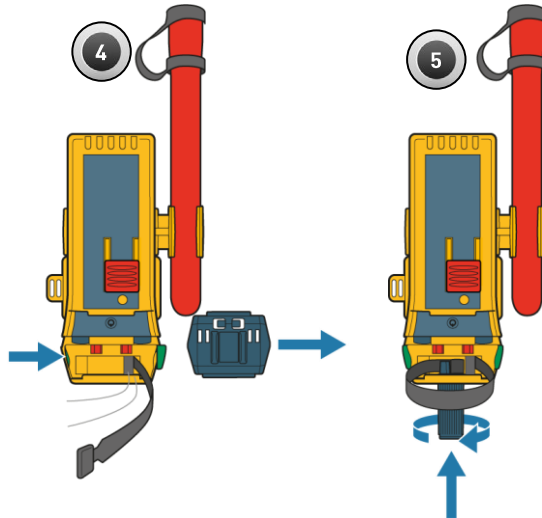

- Pass the Activation Tape loop through the round hole in the Buckle Patch and loop the tape back through the loop to lock it on (6).
- Slot the Buckle Patch over the Buckle Tape as shown (7),

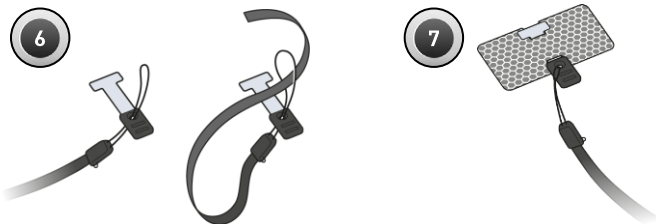

- Noting which side the slider will fit on the M100, pass the activation tape through the inner slot in the Alternative Activation Slide (red) from the underside, round the outside and through the outer slot. Loop the tape back through the inner slot (8).

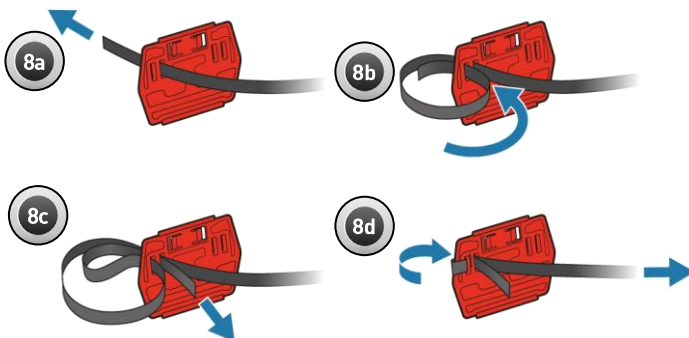

- Attach the buckle patch to the rear of the bladder so as to maximise the length of the tape needed to reach the M100 (9).
- Fold the tape over the front of the bladder, and bring the slide up to the top of the M100. Tighten the tape so it is not folding up the bladder. Now measuring the length with a ruler, tighten the tape another 100mm as shown (10).

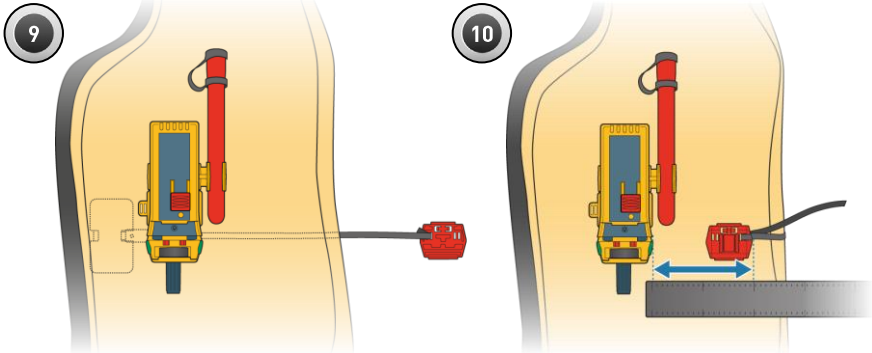



- Press and hold the green interlock button in on the side shown and fit the slide onto the front of the M100. When the slide is central, release the pressure on the Green button. The button will stay locked in place (11). Remove the Antenna winder and retain for future use.

 Ensure you have removed the Antenna Winding Tool. Leaving this in place will stop the M100 activating correctly and may restrict the bladder inflating.

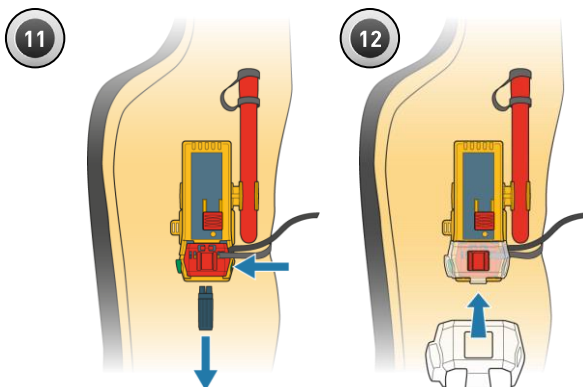
- Fit the protective cover over the front of the Activation Slide and make sure it clips into both sides of the M100 (12).



-  The red slider is not locked in place in this fitting, so the use of the Protective Cover is important to prevent accidental activation caused by movement under the life jacket cover.
- To prevent accidental loss, use the provided length of cord to also tie the M100 to a fixed point on the lifejacket. Select a secure point on the lifejacket that the cord cannot detach or untie from if the M100 is accidentally removed from its bracket. The M100 fixing point for the cord is located on the top of the unit.
-  **Ensure the M100 is securely tied to a fixed point on the lifejacket that will NOT inhibit inflation.**
- Repack the bladder into the life jacket following the manufacturer's instructions.
-  After a real activation the SOLAS tape attaching the buckle patch to the rear of the bladder should be replaced before repacking the bladder.

### 3.3 Fitting to alternative type of life jackets

Additional fitting instructions covering different styles and constructions of life jackets will be posted on the Ocean Signal web site from time to time.

## 4. Operation

**WARNING: Use only in situations of grave and imminent danger.**

**Misuse may result in a severe penalty.**

Ensure that your M100 is always fitted with an unused battery that is within the marked expiry date. Failure to do so may result in reduced operating time when used in a real emergency. Please observe the recommendations on testing in section 5.

### 4.1 Automatic Activation

When correctly packed in a lifejacket the M100 will automatically activate when the lifejacket inflates. Should the lifejacket fail to fully inflate, it may be necessary to assist the Activation Slide by pulling on the Activation Tape to fully release the Activation Slide.

### 4.2 Manual Activation



ONLY activate your M100 in situations requiring assistance in an emergency. Deliberate misuse of your M100 may result in a fine.

- To manually activate your M100 in an emergency, unclip the Protective Cover (if fitted) press in the green interlock button and slide the Activation Slide to the Left or Right. The green LED will blink every 2.5 seconds until transmissions start. The M100 will automatically start transmitting after 15 seconds.



The antenna will be automatically released. Keep the M100 well away from your eyes when activating.

- If the M100 fails to activate when the slide is removed, press the ON Key down until the green LED illuminates. Release the key.
- Upon activation, the green LED will blink every 2.5 seconds until transmissions start. The indicator LED will show eight double flashes during AIS transmission. The colour of the flash will be Red during position acquisition and green when the GPS position is being received. 121.5MHz transmission is indicated by single red flashes every 2.5 seconds.
- When operating the M100, tether the beacon to your body or the life jacket.
- Hold your beacon with the antenna standing vertically. Keep the area marked 'GPS do not obstruct' free from obstruction which would interfere with the GPS reception.

### 4.3 Deactivation

To deactivate your M100 after use or if it is accidentally activated, press the TEST/OFF Key until the LED flashes red twice, then release.



## 4.4 Rewinding the antenna

To rewind the antenna after activation or transmission testing, use the small grey Antenna Rewind tool supplied in the box. Place the moulded end of the antenna into the antenna compartment and pass the tool through the round hole in the top of the M100 and over the antenna. Rotate the tool anti-clockwise until the antenna is fully wound up. Follow the loading instructions given for your jacket style in sections 3.1 and 3.2.

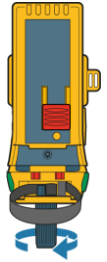

If the M100 has activated, turn it off by pressing the TEST/OFF Key until the LED flashes twice.



Rotating the antenna rewind tool in the clockwise direction may result in damage to the antenna

## 5. Testing

Routine testing of your M100 once a month is recommended to ensure it is in good working order when needed, but please follow the guidance notes below on the frequency that tests should be carried out. Please remember that each test will reduce the battery capacity slightly and reduce the operation time of your M100 during an emergency.



### 5.1 Functional test

To test your M100 is functioning correctly, press and hold the TEST/OFF Key for one second. The red LED will start flashing, indicating test mode is activated. The switch may now be released. The LED will blink red and green very quickly. After a short pause the indicator LED will flash green or amber to show a pass or red to show fail status and the unit will automatically turn off. The test result is repeated with a short delay between results.

The number of flashes in each group indicates the battery status or failure as shown in Table 1. This battery indicator is the electronic witness that the M100 has been activated.

Green / Amber Indicator <i>Changes to Amber after 1 hour of use</i>		Red indicator status
No of Flashes	No of Hours Used	Type of Failure
1 Flash	0 to 2hrs (Green)	
2 Flashes	2 to 4hrs (Amber)	Frequency generation
3 Flashes	4 to 6hrs (Amber)	Tx Power - AIS
4 Flashes	6 to 8hrs (Amber)	Battery failed
5 Flashes	8 to 10hrs (Amber)	No GPS Fix
6 Flashes	Over 10hrs (Amber)	Tx Power - homer



**Table 1: Pass/Fail indication**

-  The amber test result indicates the battery has been used for over two hours or the allowed number of tests has been exceeded. The M100 will still operate normally in distress, but the battery should be replaced immediately to ensure the full operating life when your M100 is needed.
-  The Pass/Fail status indication is repeated a second time after a short delay.

## **5.2 AIS transmission test**

To initiate an AIS transmission and GPS test, press and hold the TEST/OFF Key for 10 to 15 seconds. The red LED will start flashing and then become steady after five seconds. After a further five seconds, the LED will start flashing slowly. Release the key. The LED will give a long red flash followed by a short green flash until GPS lock is achieved. After GPS lock is obtained, the M100 will transmit a single burst of AIS messages indicated by eight double flashes of the green LED. The indicator LED will flash green or amber to show a pass or red to show fail status, as indicate in Table 1. The M100 will then automatically turn off.

After a successful test, the message “M100 TEST” will be displayed on a suitable AIS receiver or plotter display.

-  The AIS/GPS test should only be attempted with a clear view of the sky.
-  The AIS/GPS test is limited to a total of 120 tests over the life of the battery.
-  If no tests remain the GPS test cannot be initiated and the red LED will flash four times.

## 6. Appendix

### 6.1 Maintenance and Troubleshooting

Your M100 will require little maintenance except periodic cleaning, if required. Always use a damp cloth to clean the case and dry thoroughly. Do not use solvents or other cleaning fluids as this may cause the plastics to deteriorate. Ensure the antenna is free to unwind.

### 6.2 Batteries

The M100 contains Lithium metal batteries for long operating life. Your battery must be replaced either prior to the expiry date or after the M100 has been used, even if only activated for a short period of time. Battery replacement must be carried out at an Ocean Signal authorised battery replacement centre.

### 6.3 Transport

When shipping your M100 the following guidance and regulations should be followed, but you are advised to contact your nearest battery replacement centre or Ocean Signal prior to shipping as regulations may have changed.

- Always pack your M100 securely in a stout cardboard carton. Ocean Signal advises that you keep the original packaging in case of return for service.
- For surface transport the M100 may be shipped under special provision 188.
- For air transport the M100 should be shipped as category UN3091 and packed under IATA packing instruction 970 section II. If you are hand carrying your M100 on an aircraft please contact your airline for advice.
- Consult the manufacturer's instructions for information on carrying a life jacket in your luggage on board aircraft.

### 6.4 Disposal

Care should be taken when disposing of your M100 when it is no longer required. It is recommended to remove the battery from the M100. Remove the lid four screws (TORX TX6) and then the rear of the body with the six screws (four are under the rear label). Dispose of the battery in accordance with local waste regulations. **Please note that the M100 is not user serviceable and opening the case will invalidate the warranty.**

## 6.5 Specifications

### Homing Transmission

Transmit Power ..... 50mW  
 Frequency ..... 121.5MHz  
 Modulation ..... AM, Swept tone

### AIS transmission

Transmit Power (EIRP) ..... 1Watt  
 Frequency ..... 161.975/162.025MHz ±500Hz  
 Baud rate ..... 9600baud  
 Synchronisation ..... UTC  
 Messages ..... Message 1 (Position), Message 14 (MOB status)  
 Repetition interval ..... 8 messages/minute  
 ..... Message 14 sent twice every 4 minutes

### Environmental

Temperature range (operational) ..... -20°C - +55°C  
 Temperature range (storage) ..... -30°C - +70°C  
 Damp Heat (humidity) ..... 40°C at 93%  
 Drop (hard surface) ..... 1m : 6 sides  
 Designed to meet Drop (water) ..... 20m : 3 sides  
 Water immersion ..... 2 bar : >60 minutes  
 Thermal Shock ..... 45°C into 100mm of water : >1hour

### Physical

Weight ..... 152 grams  
 Dimensions ..... 132mm x 52mm x27mm  
 ..... 76mm over bracket

## 6.6 Country of Intended Use

Austria	✓	Germany	✓	Poland	✓
Belgium	✓	Greece	✓	Portugal	✓
Bulgaria	✓	Hungary	✓	Romania	✓
Cyprus	✓	Ireland	✓	Slovakia	✓
Croatia	✓	Italy	✓	Slovenia	✓
Czech Republic	✓	Latvia	✓	Spain	✓
Denmark	✓	Lithuania	✓	Sweden	✓
Estonia	✓	Luxembourg	✓	United Kingdom	✓
Finland	✓	Malta	✓		
France	✓	Netherlands	✓		

Note: the Country of Intended Use Table Is a requirement for Europe only. It does not imply that the M100 is limited to use in these countries only.

## **6.7 Approvals**

### **6.7.1 European Declaration of Conformity**

Hereby, Ocean Signal Ltd. declares that the radio equipment type M100 and M100X are in compliance with Directive 2014/53/EU.

See [http://oceansignal.com/wordpress/wp-content/uploads/M100\\_RED\\_DofC.pdf](http://oceansignal.com/wordpress/wp-content/uploads/M100_RED_DofC.pdf)



## **6.8 Limited Warranty**

Your Ocean Signal M100 is warranted against manufacturing defects in materials and workmanship for a period of two years from the date of purchase and in accordance with the following conditions.

Ocean Signal will at its discretion, repair or replace faulty product free of charge excluding the cost of shipping. Proof of purchase shall be required in order for a warranty claim to be valid from the original purchaser. All claims shall be made in writing to Ocean Signal or an approved service dealer or distributor.

Ocean Signal shall not be liable to the buyer under the above warranty:

- for any repairs or modifications carried out on the M100 using parts that are not supplied or approved by the manufacture Ocean Signal including batteries and for work carried out other than by Ocean Signal or approved service dealers,
- for any part, material or accessory that is not manufactured by Ocean Signal the consumer will be covered by the guarantee / warranty offered to Ocean Signal by the manufacturer or supplier of such a component,
- for product which has not been fully paid for,
- for any product supplied by Ocean Signal to a customer under an alternative warranty or commercial agreement,
- for the cost of shipping product to and from the customer.

The Battery is only warranted until the date of expiry and provided the unit is tested in accordance with the information in the user manual. This warranty does not apply to a used battery as indicated by the electronic witness (see section 5.1).

The following specific item is excluded from this warranty:

- Damage to the antenna

This warranty does not affect your statutory rights. This warranty is to be interpreted under English law.

For further assistance please contact our Technical Service Department.

Email: [service@oceansignal.com](mailto:service@oceansignal.com)



Ocean Signal Ltd.  
Unit 4, Ocivan Way  
Margate  
CT9 4NN  
United Kingdom

[info@oceansignal.com](mailto:info@oceansignal.com)  
[www.oceansignal.com](http://www.oceansignal.com)

